





*Thermoforming Engineering Studio*  
*Manufacturer with Largest Size in India*



  98250 67570  sales@hitech-products.com | www.hitech-products.com  
 61, Navdurga Industrial Park, At & PO Sankarda, Ta & Dist. Vadodara, Gujarat-391350, Bharat



## inception

In 2014 founder director to the company ventured into his first professional and passionate genre, called THERMOFORMING of plastics sheets in plastics industry.

## Who we are



## conceptualisation

an experience CEO and his time tested team of engineers and supervisors using latest designing software help customer visualize the product well before it goes actually to shop floor, minimizing the input cost. inducing decision making help out of vast experience of materials , its selection and thermoformability,

## design of product

being critical portion of production feasibility, we understand the demand in all aspects and help out to achieve the exact product considering thermoformability and its fitting to near by parts OR simply we deliver as per the dwg. by being an obedient thermoformer..



## tool room

to achieve the product resulting out of brain storming , designing and material selection, the technicians in tool room put their max to match the deadlines and accuracy both. let it be manual or CNC base accuracy is as accurate as hair line difference. we have decades of experience of manual tooling technicians along with installed larger 4 axis CNC machine as well.



## FORCE Ambulance ABS Interior Panels

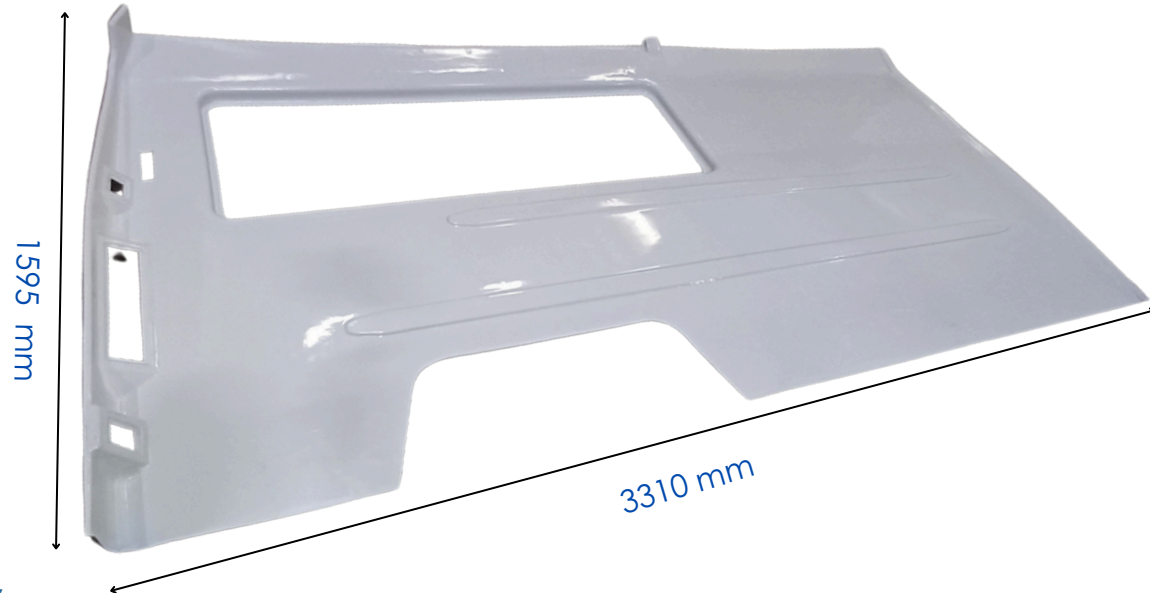

### production ability

we have installed capacity of running the production in 3 shifts as per demand. moreover we have claimably largest thermoforming / vacuum forming operating machine in BHARAT. the size of machine is 4200mm x 2200mm with day light of 590mm. smallest part from us can be of size 200mm x 200mm.

### post production Finishing

experienced tool room technicians , quickly design and prepare a jigs and fixture for finishing of critical products although installed CNC machine with 4 axis operations is as big as 4000mm x 2000mm with depth working of 600mm. these advantages enable us to deliver the products in time to our valuable customers.

**Now please spare some more to go through our product gallery in next few pages.**



## FORCE Ambulance ABS Interior Panels

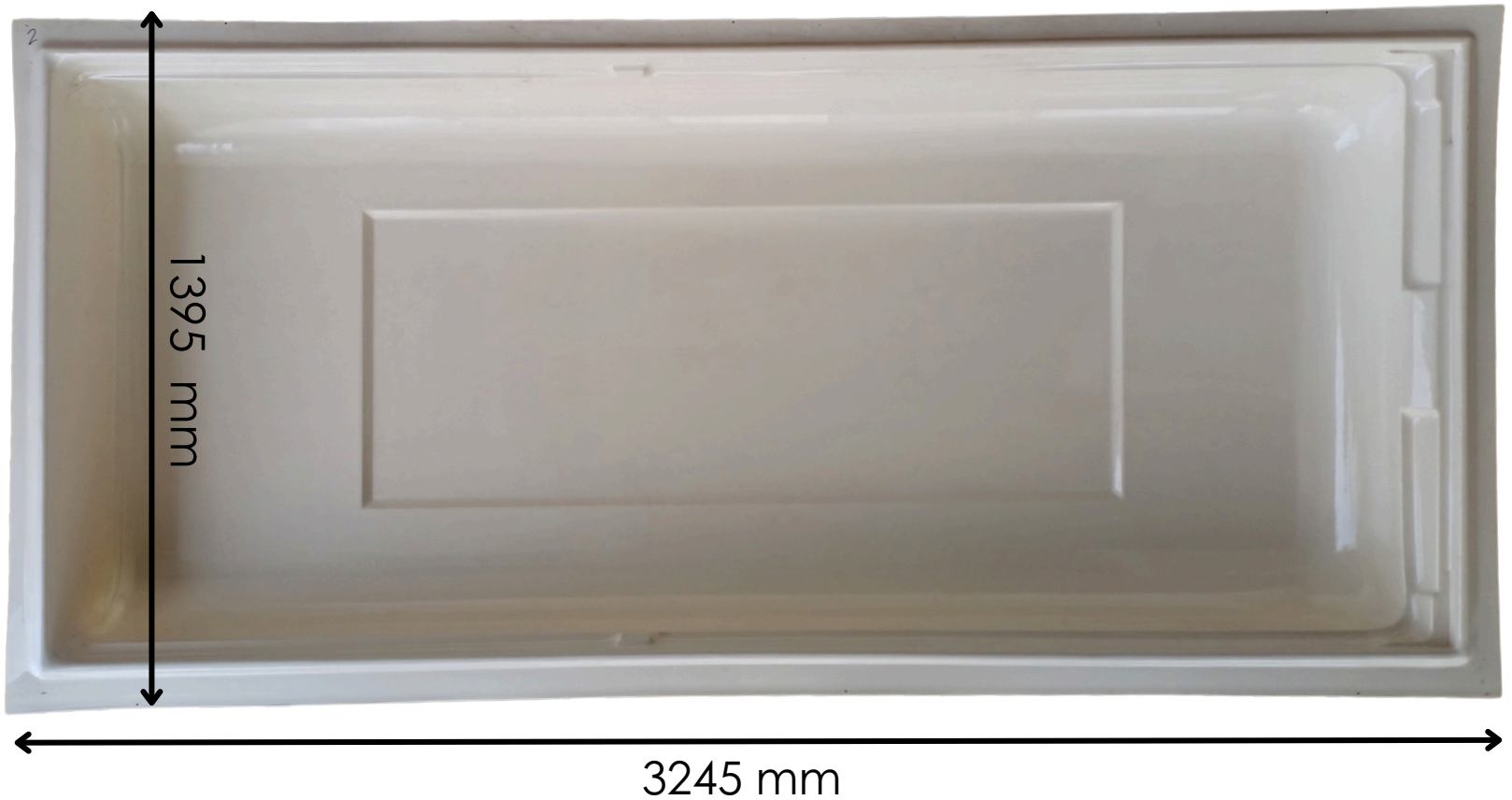

One Piece Patient side Roof



## FORCE Ambulance ABS Interior Panels



One piece vacuum moulded  
RHS from ABS sheets



## FORCE Ambulance ABS Interior Panels

RHS panel of FORCE 3350

- One piece
- aesthetics
- functional
- durability

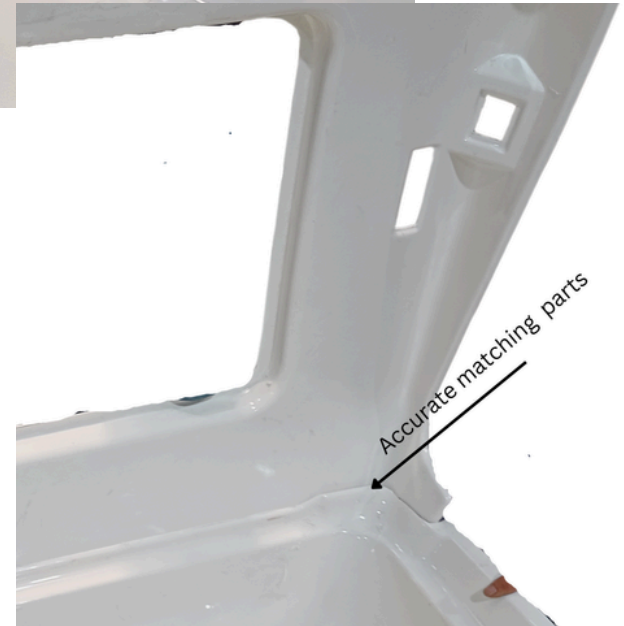
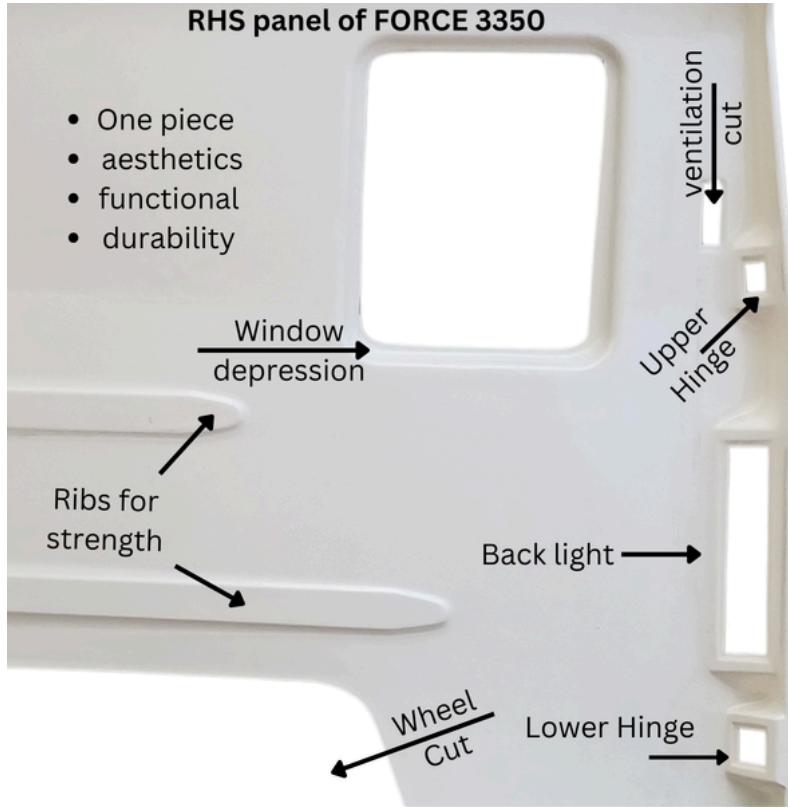



## FORCE Ambulance ABS Interior Panels

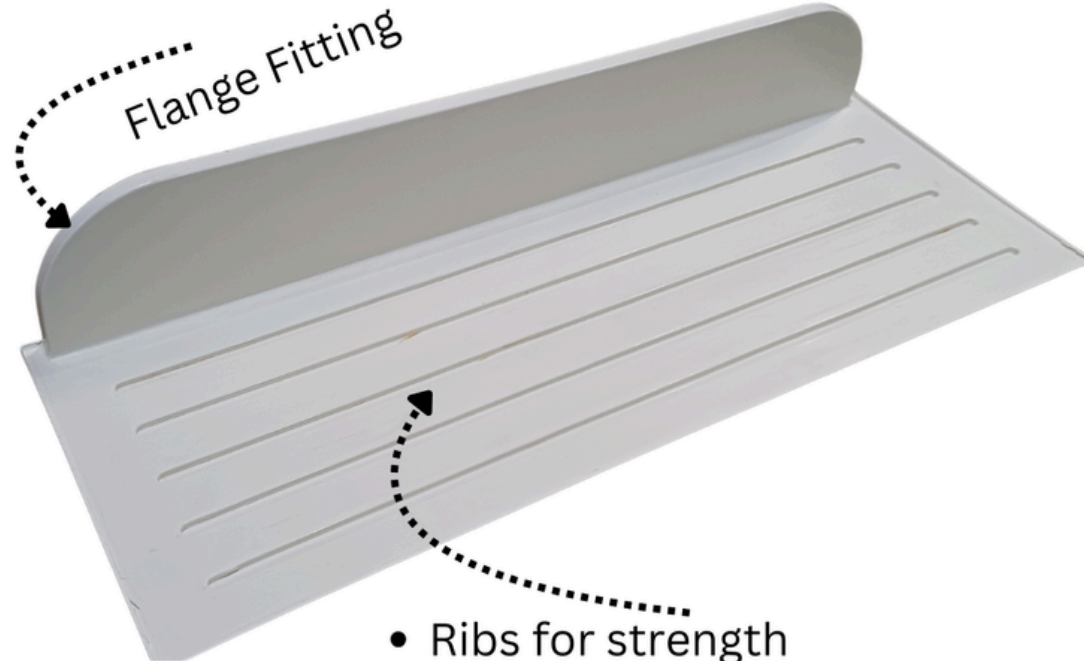

- Ribs for strength
- Made from 4.0mm thk. sheet
- Corners with flanges

**A C COVER**



# FORCE Ambulance ABS Interior Panels

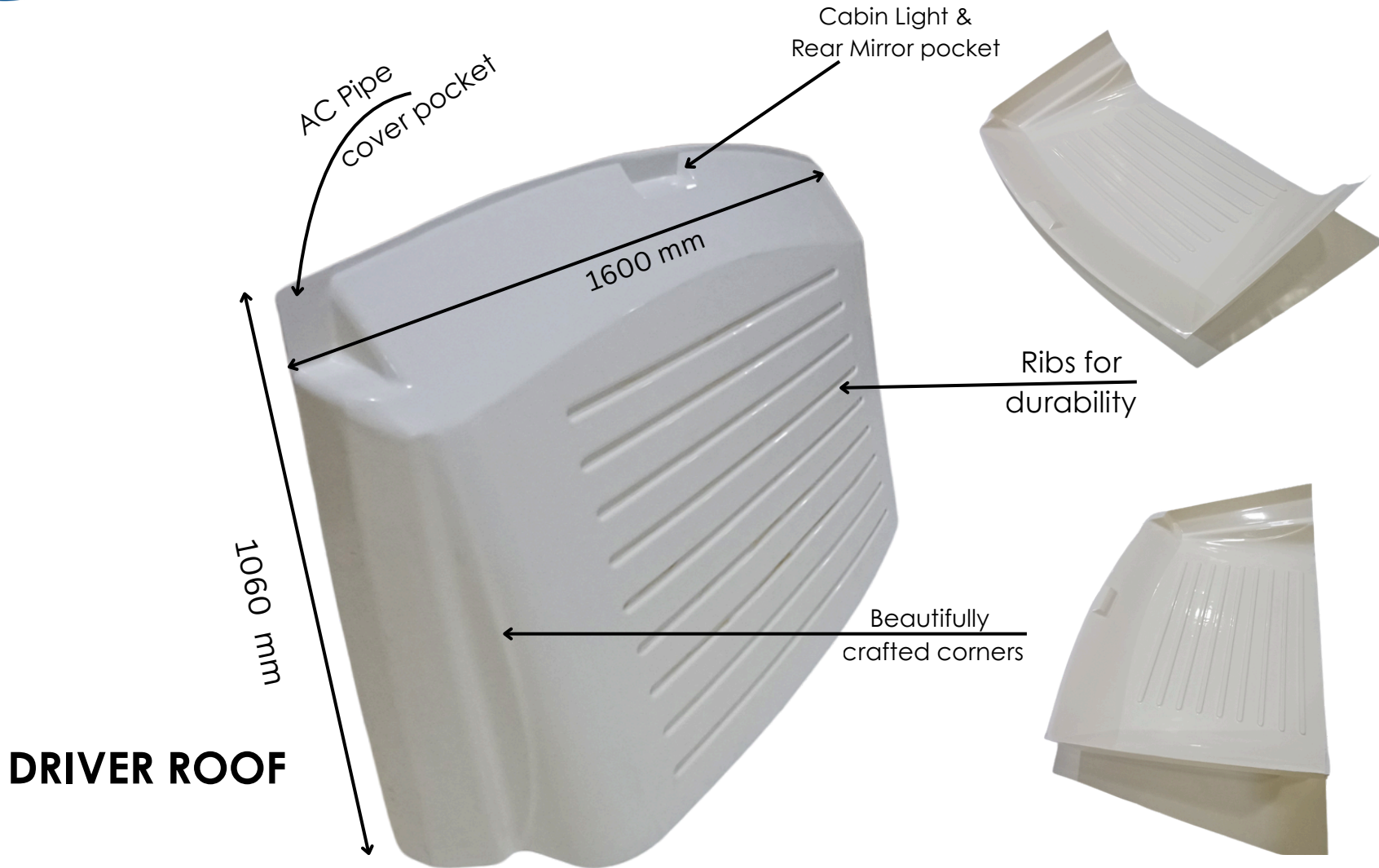



# FORCE Ambulance ABS Interior Panels

## HAT RACK

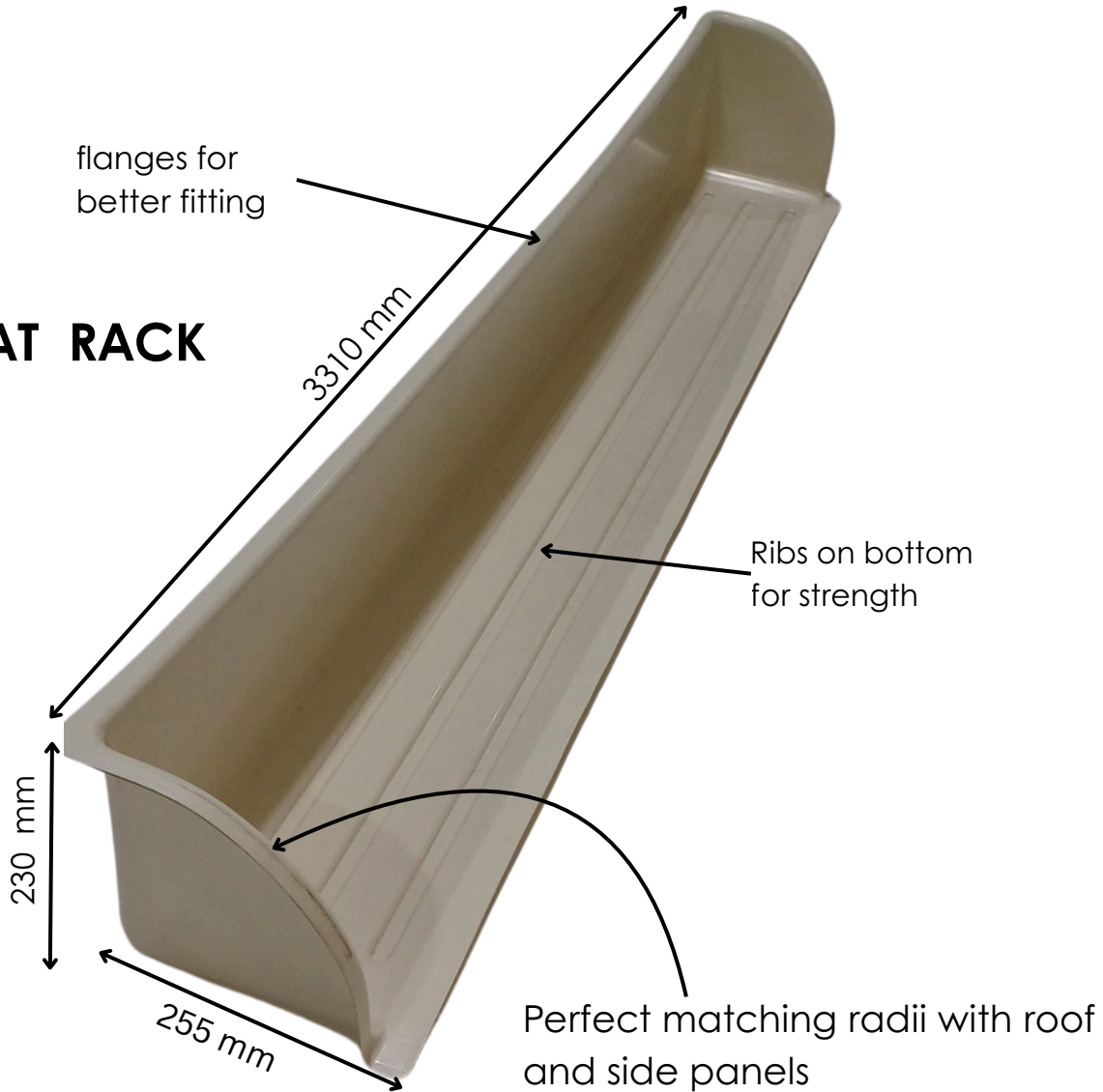



## FORCE Ambulance ABS Interior Panels

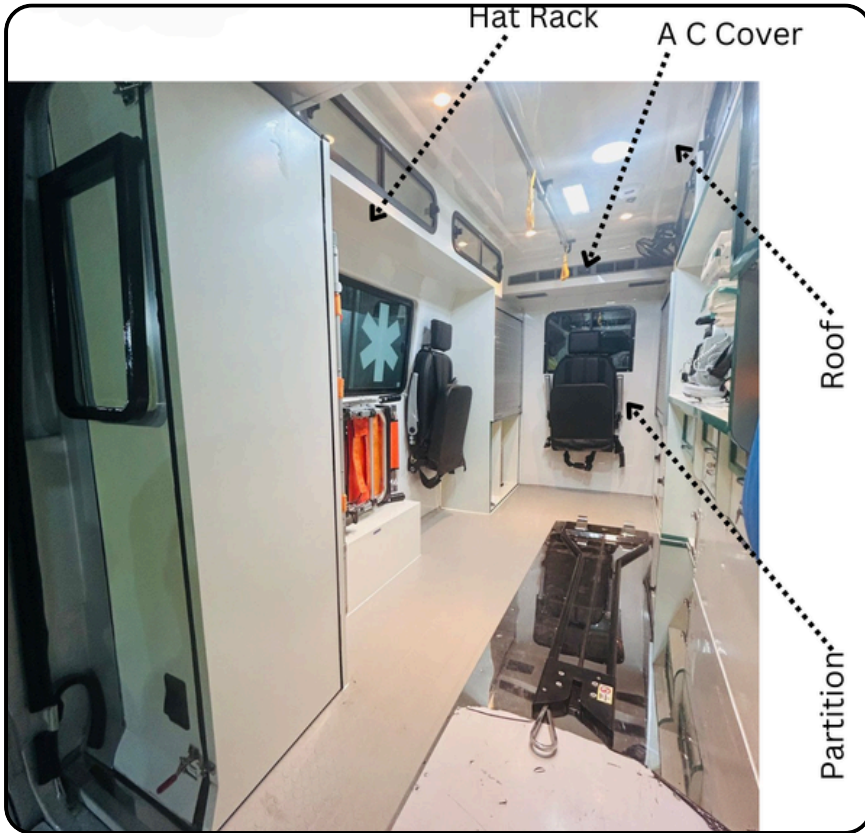

FITTED WITH ABS PMMA HIGH GLOSS PANELS



## WINGER Ambulance ABS Interior Panels



Tata Winger Ambulance Tata Winger Ambulance's Interior panels developed using ABS & virtually unbreakable Polycarbonate Sheets.

Almost all utilities are taken care of serving a patient.





## BUS SLEEPER COACH



Illustrative design of Back & Ceiling of the Sleeper coach can be produced using ABS leather finish sheets.

Innovative and utility designs is what we are looking for to develop and serve the industry.



## BUS SLEEPER COACH



Innovative and utility designs is what we are looking for to develop and serve the industry.



## BUS SLEEPER COACH



Illustrative design of Back & Ceiling of the Sleeper coach can be produced using ABS leather finish sheets.

Innovative and utility designs is what we are looking for to develop and serve the industry.



## BUS SLEEPER COACH



Innovative and utility designs is what we are looking for to develop and serve the industry.



## BUS SLEEPER COACH



Innovative and utility designs is what we are looking for to develop and serve the industry.



## BUS SLEEPER COACH



Illustrative design of Back & Ceiling of the Sleeper coach can be produced using ABS leather finish sheets.



## BUS SLEEPER COACH



Illustrative design of Back & Ceiling of the Sleeper coach can be produced using ABS leather finish sheets.



## BUS SLEEPER COACH





# BUS SLEEPER COACH



## *Large Size Side Board*

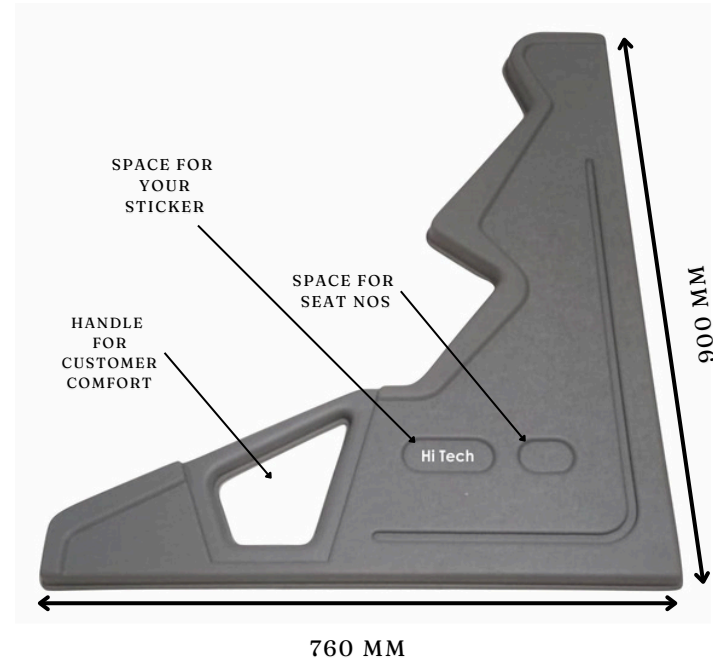



# BUS SLEEPER COACH

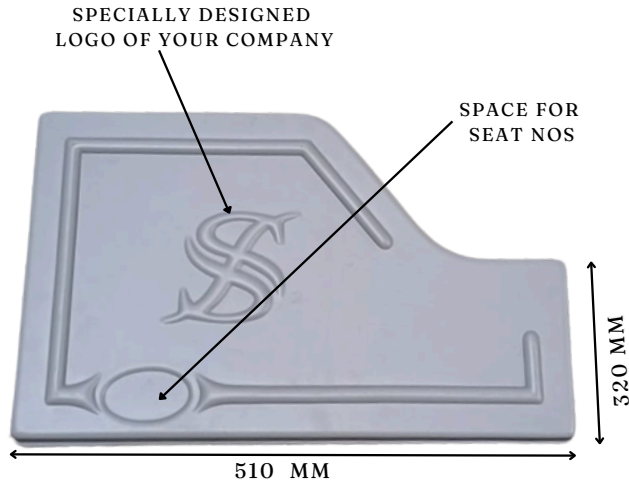

*Small Size Side Board*

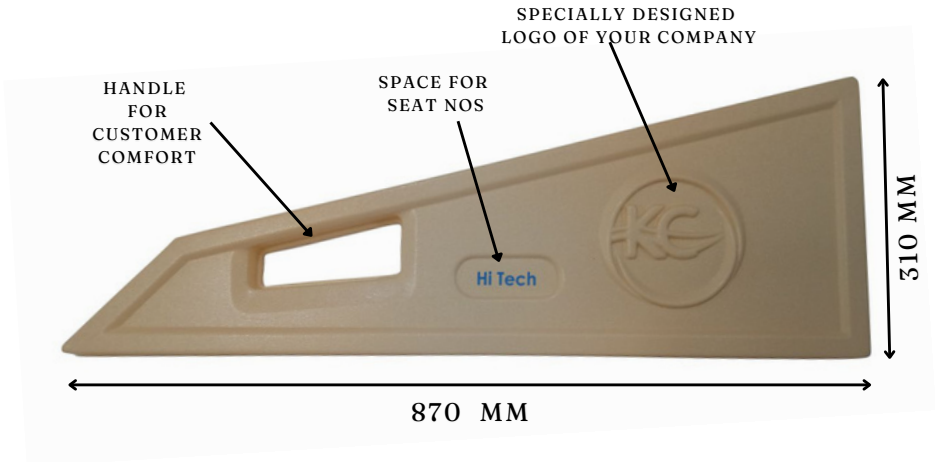

*Medium Size Side Board*



# BUS SLEEPER COACH

*Single sleeper side Combo Panel*

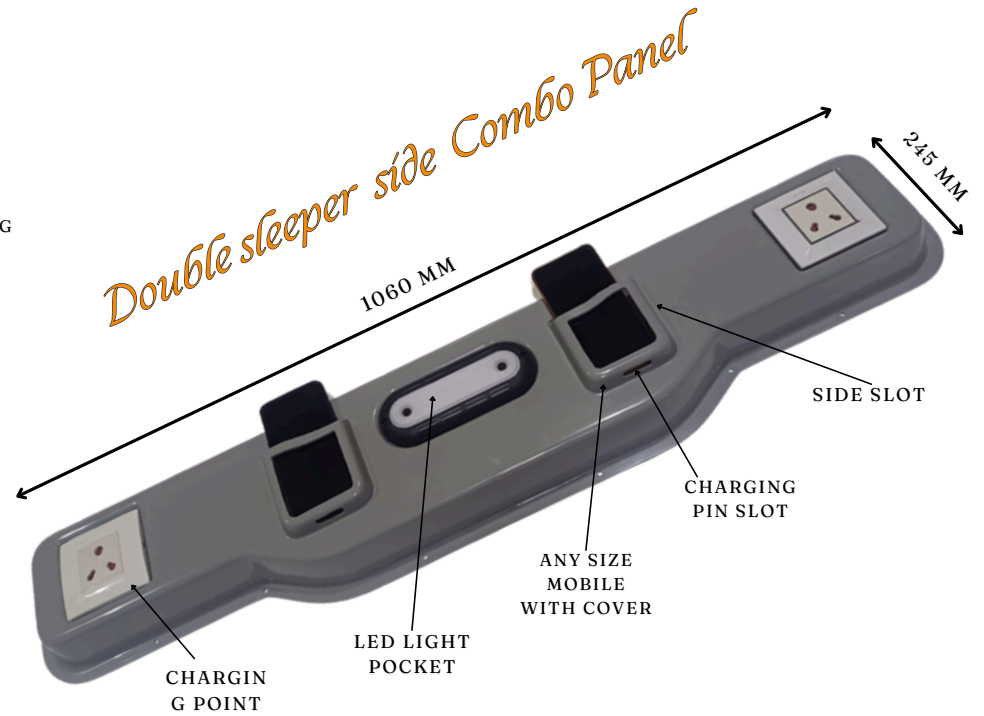
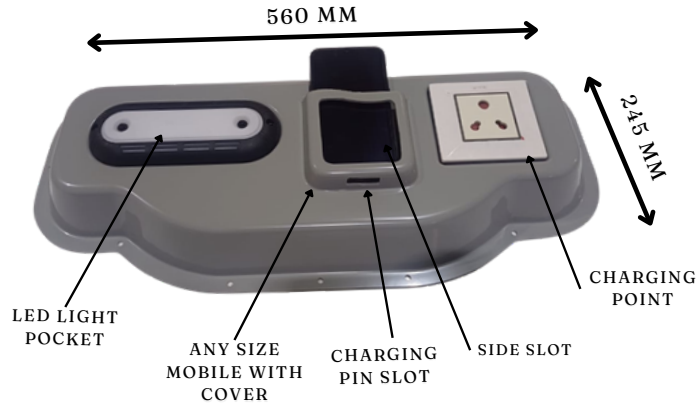



# BUS SLEEPER COACH

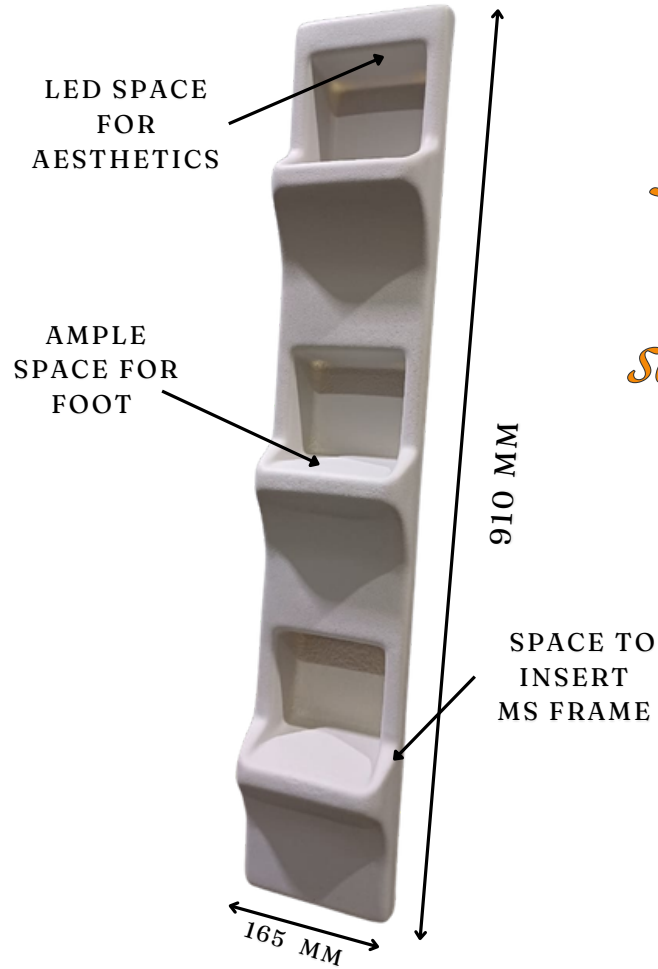

*Steps to  
climb  
safely on  
upper  
deck*

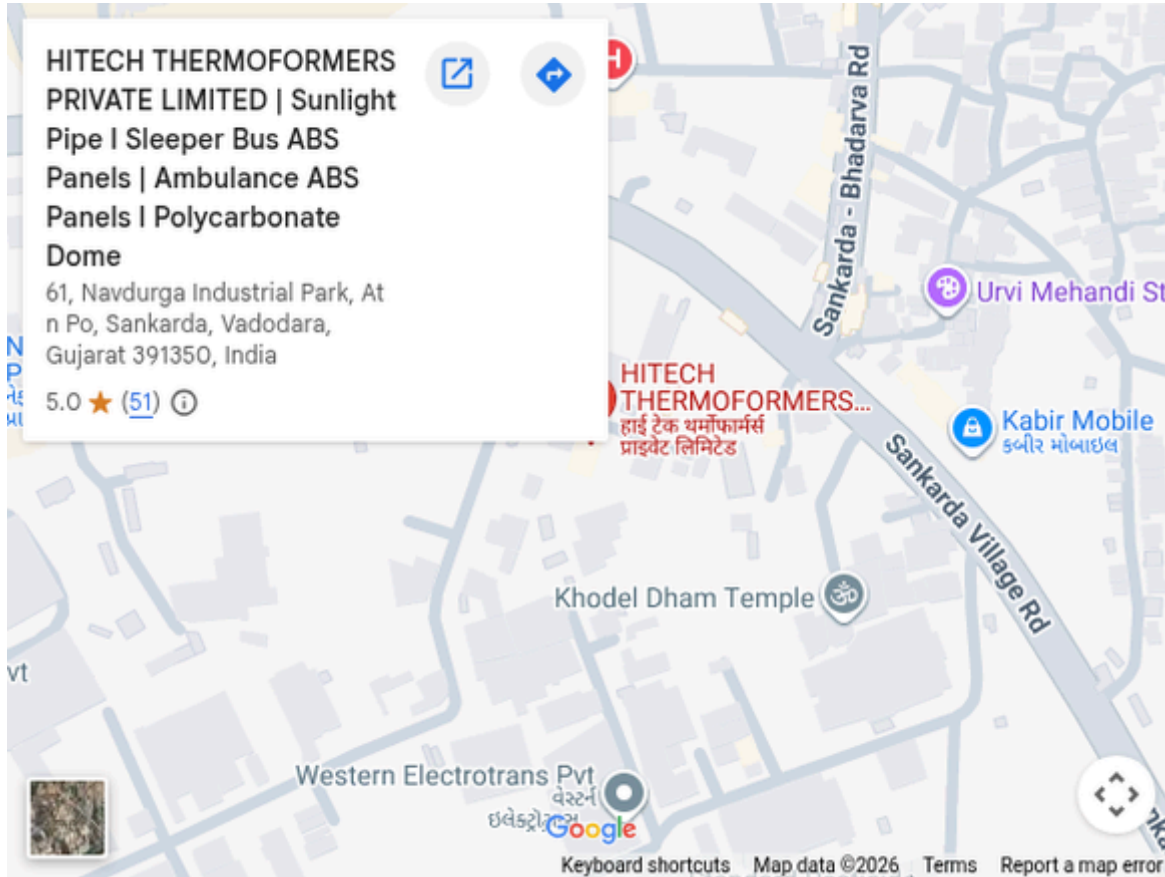

Thermoformers private limited



98250 67570 | 98796 07570



sales@hitech-products.com | www.hitech-products.com



61, Navdurga Industrial Park, At & PO Sankarda, Ta & Dist. Vadodara, Gujarat-391350, Bharat